

BEDDING PACKAGING SPECS

Noble Excellence Villa

All Artwork Is For Reference Only

WOVEN LABEL

VIL50LW



PRE-TICKET STICKER

DMSML-125P

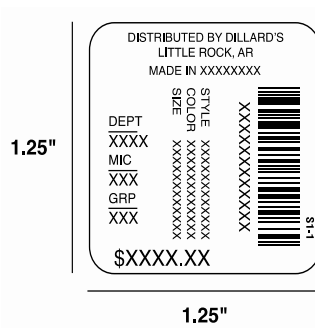

LAW LABEL

Use As Needed

Added by Vendor

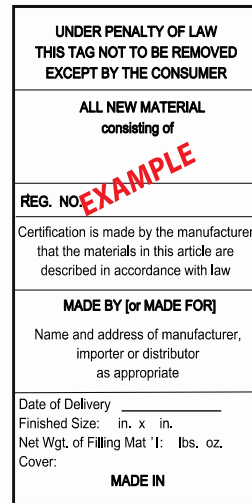

PRINTED INSERTS COLORS

Front Inserts

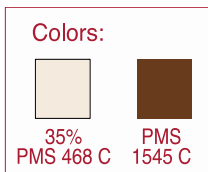

MATTE FINISH

Back Inserts

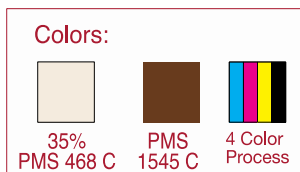

MATTE FINISH

PAPER WEIGHT FOR PRINTED INSERTS

Paper weight: 18PTC1S: 280gsm

VINYL BAG: TWILL FABRIC, ZIPPER AND POM PULL COLOR

Natural; 35% PMS 468 C or PMS 12-0703 TCX

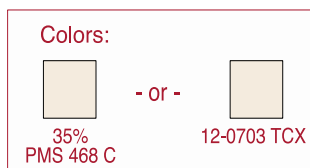

BEDDING PACKAGING SPECS

COMFORTERS, COMFORTER SETS 23" x 23"

FRONT

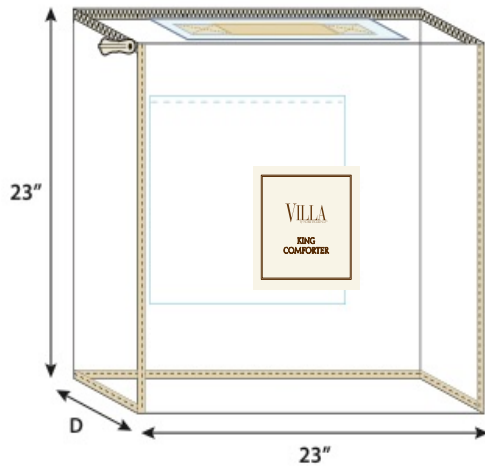

Front Pocket Size: 6.25" x 6.25"
Front Insert Size: 6" x 6"

BACK

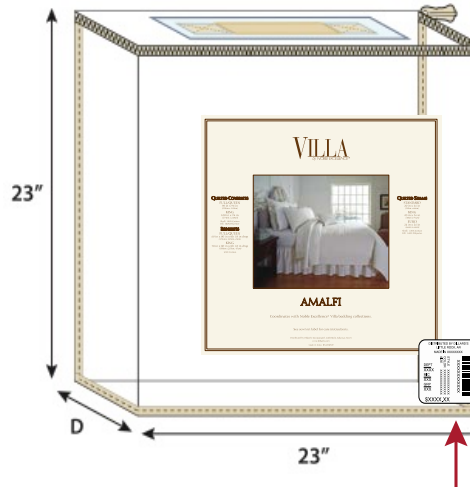

Back Pocket Size: 14.25" x 14.25"
Back Insert Size: 14" x 14"

Preticket Sticker

- Lower right-hand corner on outside of vinyl bag
- Price reads horizontally

VINYL BAG AND INSERT SPECS

BAG CODE #	DL-NAT-23x23
SIZE	23" x 23" x Gusset, Thread to Thread
POCKETS	FRONT (non-zipper side): 6.25" x 6.25" centered
	8.375" From Bottom; 8.375" From Right Side; Center 3.2 Gauge Non-Phthalate PVC
	BACK (zipper side) : 14.25" x 14.25" centered
	3.875" From Bottom; 4.375" From Right Side; Center 3.2 Gauge Non-Phthalate PVC
INSERT SIZES	FRONT: 6" x 6"
	BACK: 14" x 14"
BODY	All Panels: 6.0 Gauge Non-Phthalate PVC
TRIM	2 Panel Construction Trim: Cotton Twill Fabric; NATURAL (PMS #12-0703 TCX)
THREAD	On Trim: 40/2 Polyester Thread, NATURAL (PMS #12-0703 TCX)
ZIPPER	5# Filament Zipper (PMS #12-0703 TCX) NATURAL; On Top Panel
SLIDER / PULL	1 Piece #5 Slider With POM Pull; NATURAL (PMS #12-0703 TCX)
HANDLE	Top Panel: 1 Piece cotton twill fabric NATURAL (PMS #12-0703 TCX) Strap Handle; 12" x 2"; Center of top panel; Double layer twill cotton with 8G clear PVC inside, go through die cut holes (with heat seal seams) on top, sewn with "X" stitches under top panel, have PVC reinforcement under center of top panel. Heat seal all around reinforcement PVC.
GUSSET	Vendor determines gusset size

BEDDING PACKAGING SPECS

QUILTS, QUILT SETS, COVERLETS, COVERLET SETS, BEDSPREADS 19" x 15"

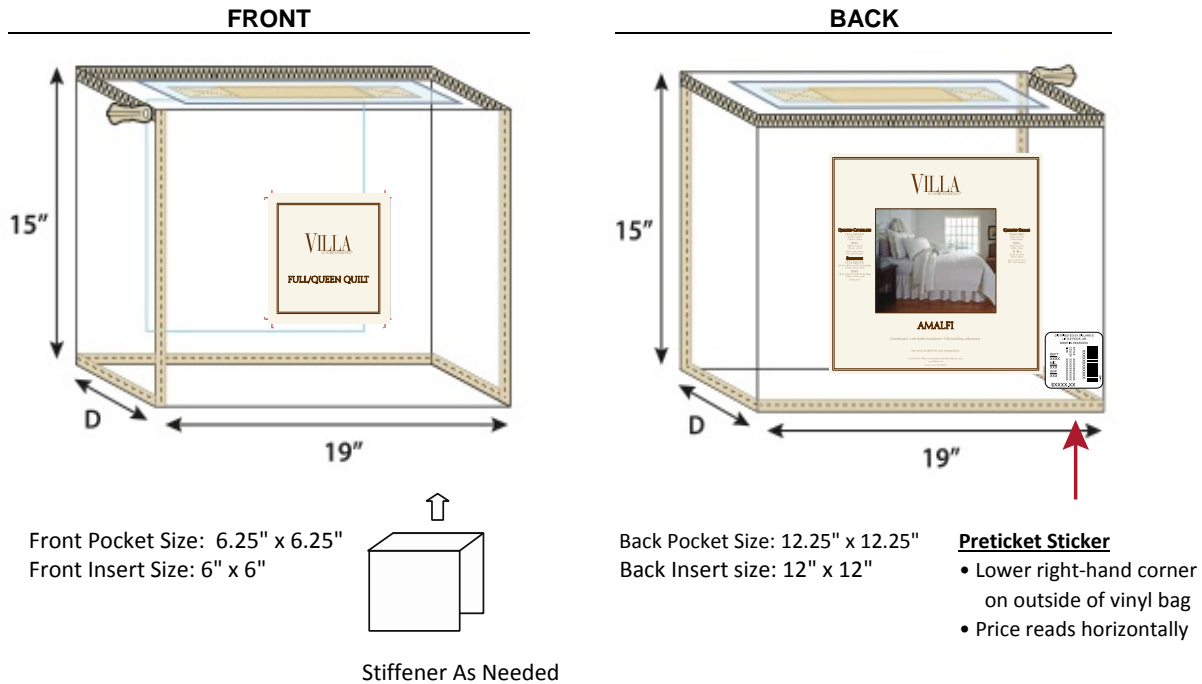

VINYL BAG AND INSERT SPECS

BAG CODE #	DL-NAT-19x15
SIZE	19" x 15" x Gusset, Thread to Thread
POCKETS	FRONT (non-zipper side): 6.25" x 6.25" centered
	4.375" From Bottom; 6.375" From Right Side; Center 3.2 Gauge Non-Phthalate PVC
	BACK (zipper side) : 12.25" x 12.25" centered
	0.875" From Bottom; 3.375" From Right Side; Center 3.2 Gauge Non-Phthalate PVC
INSERT SIZES	FRONT: 6" x 6"
	BACK: 12" x 12"
BODY	All Panels: 6.0 Gauge Non-Phthalate PVC
TRIM	2 Panel Construction Trim: Cotton Twill Fabric; NATURAL (PMS #12-0703 TCX)
THREAD	On Trim: 40/2 Polyester Thread, NATURAL (PMS #12-0703 TCX)
ZIPPER	#5 Filament Zipper (PMS #12-0703 TCX) NATURAL; On top panel
SLIDER / PULL	1 Piece #5 Slider With POM Pull; NATURAL (PMS #12-0703 TCX)
HANDLE	Top Panel: 1 Piece cotton twill fabric NATURAL (PMS #12-0703 TCX) Strap Handle; 12" x 2"; Center of top panel; Double layer twill cotton with 8G clear PVC inside, go through die cut holes (with heat seal seams) on top, sewn with "X" stitches under top panel, have PVC reinforcement under center of top panel.
GUSSET	Vendor determines gusset size

BEDDING PACKAGING SPECS

DUVETS, DUVET SETS 13" x 10"

FRONT

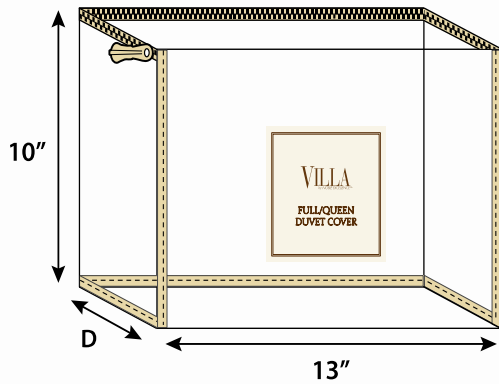

Front Pocket Size: 4.25" x 4.25"
Front Insert Size: 4" x 4"

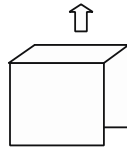

Stiffener Required

BACK

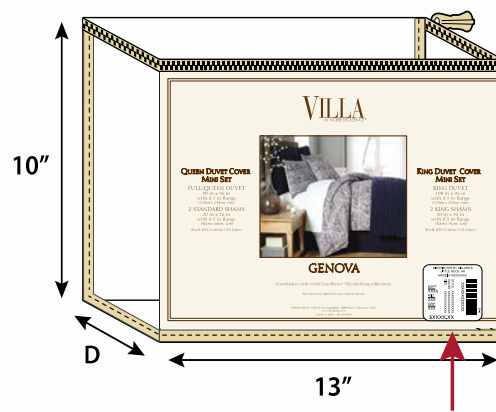

No Back Pocket
Back Insert size: 12" x 9"

Preticket Sticker

- Lower right-hand corner on outside of vinyl bag
- Price reads horizontally

VINYL BAG AND INSERT SPECS

BAG CODE #	DL-NAT-13x10
SIZE	13" x 10" x Gusset, Thread to Thread
POCKET(S)	FRONT (non-zipper side): 4.25" x 4.25" centered
	2.875" From Bottom; 4.375" From Right Side; Center 3.2 Gauge Non-Phthalate PVC
	BACK (zipper side) No Pocket
INSERT SIZES	FRONT: 4" x 4"
	BACK: 12" x 9"
BODY	All Panels: 6.0 Gauge Non-Phthalate PVC
TRIM	2 Panel Construction Trim: Cotton Twill Fabric; NATURAL (PMS #12-0703 TCX)
THREAD	On Trim: 40/2 Polyester Thread, NATURAL (PMS #12-0703 TCX)
ZIPPER	3# Filament Zipper (PMS #12-0703 TCX) NATURAL; On Top Panel
SLIDER / PULL	1 Piece #3 Slider With POM Pull; NATURAL (PMS #12-0703 TCX)
GUSSET	Vendor determines gusset size

BEDDING PACKAGING SPECS

SHAMS, BED SKIRTS, DRAPES, VALANCES 11" x 9"

FRONT

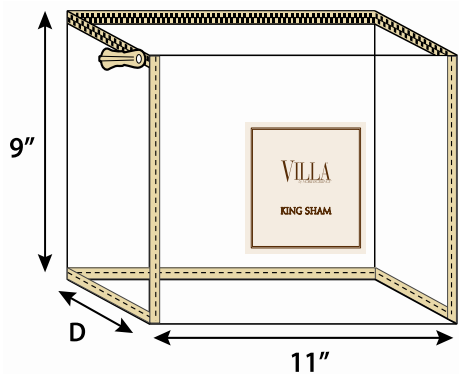

Front Pocket Size: 4.25" x 4.25"
Front Insert Size: 4" x 4"

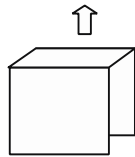

Stiffener Required

BACK

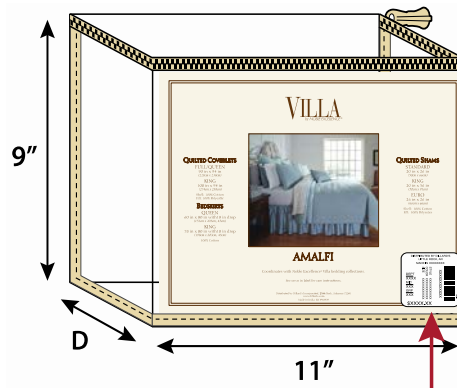

No Back Pocket
Back Insert size: 10.5" x 8"

Preticket Sticker

- Lower right-hand corner on outside of vinyl bag
- Price reads horizontally

VINYL BAG AND INSERT SPECS

BAG CODE #	DL-NAT-11x9
SIZE:	11" x 9" x Gusset, Thread to Thread
POCKET(S)	FRONT (non-zipper side): 4.25" x 4.25" centered 2.375" From Bottom; 3.375" From Right Side; Center 3.2 Gauge Non-Phthalate PVC
	BACK (zipper side) No Pocket
INSERT SIZES	FRONT: 4" x 4" BACK: 10.5" x 8"
BODY	All Panels: 6.0 Gauge Non-Phthalate PVC
TRIM	2 Panel Construction Trim: Cotton Twill Fabric; NATURAL (PMS #12-0703 TCX)
THREAD	On Trim: 40/2 Polyester Thread, NATURAL (PMS #12-0703 TCX)
ZIPPER	3# Filament Zipper (PMS #12-0703 TCX) NATURAL; On Top Panel
SLIDER / PULL	1 Piece #3 Slider With POM Pull; NATURAL (PMS #12-0703 TCX)
GUSSET	Vendor determines gusset size

BEDDING PACKAGING SPECS

Studio D

All Artwork Is For Reference Only

WOVEN LABEL

SD50LW



PRE-TICKET STICKER

DMSML-125P

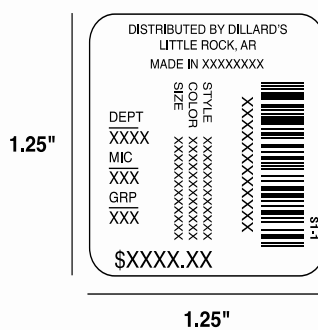

LAW LABEL

Use As Needed

Added by Vendor

<p>UNDER PENALTY OF LAW THIS TAG NOT TO BE REMOVED EXCEPT BY THE CONSUMER</p>
<p>ALL NEW MATERIAL consisting of</p>
<p>REG. NO. EXAMPLE</p>
<p>Certification is made by the manufacturer that the materials in this article are described in accordance with law</p>
<p>MADE BY [or MADE FOR] Name and address of manufacturer, importer or distributor as appropriate</p>
<p>Date of Delivery _____ Finished Size: in. x in. Net Wgt. of Filling Mat'l: lbs. oz. Cover:</p>
<p>MADE IN</p>

PRINTED INSERTS COLORS

Front Inserts

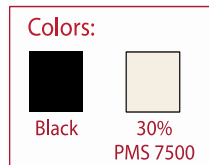

Back Inserts

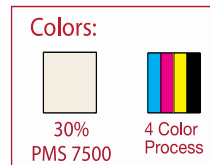

MATTE FINISH

MATTE FINISH

PAPER WEIGHT FOR PRINTED INSERTS

Paper weight: 18PTC1S: 280gsm

VINYL BAG: TWILL FABRIC, ZIPPER AND POM PULL COLOR

Natural; 35% PMS 468 C or PMS 12-0703 TCX

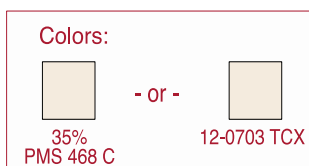

BEDDING PACKAGING SPECS

COMFORTERS, COMFORTER SETS 23" x 23"

FRONT

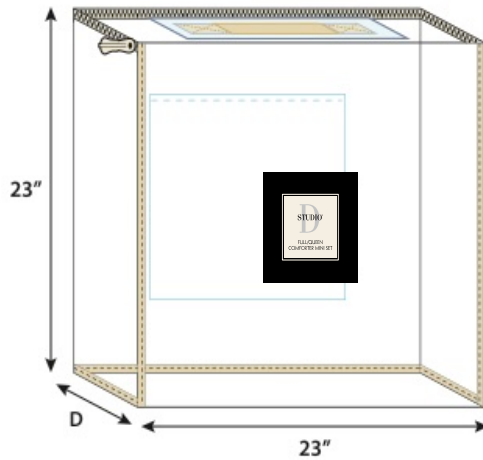

Front Pocket Size: 6.25" x 6.25"
Front Insert Size: 6" x 6"

BACK

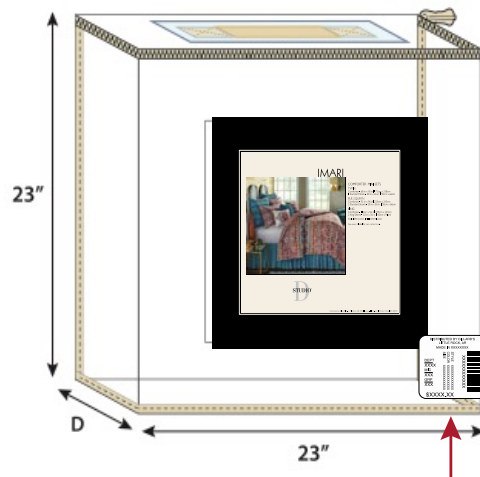

Back Pocket Size: 14.25" x 14.25"
Back Insert Size: 14" x 14"

Preticket Sticker

- Lower right-hand corner on outside of vinyl bag
- Price reads horizontally

VINYL BAG AND INSERT SPECS

BAG CODE #	DL-NAT-23x23
SIZE	23" x 23" x Gusset, Thread to Thread
POCKETS	FRONT (non-zipper side): 6.25" x 6.25" centered
	8.375" From Bottom; 8.375" From Right Side; Center 3.2 Gauge Non-Phthalate PVC
	BACK (zipper side) : 14.25" x 14.25" centered
	3.875" From Bottom; 4.375" From Right Side; Center 3.2 Gauge Non-Phthalate PVC
INSERT SIZES	FRONT: 6" x 6"
	BACK: 14" x 14"
BODY	All Panels: 6.0 Gauge Non-Phthalate PVC
TRIM	2 Panel Construction Trim: Cotton Twill Fabric; NATURAL (PMS #12-0703 TCX)
THREAD	On Trim: 40/2 Polyester Thread, NATURAL (PMS #12-0703 TCX)
ZIPPER	5# Filament Zipper (PMS #12-0703 TCX) NATURAL; On Top Panel
SLIDER / PULL	1 Piece #5 Slider With POM Pull; NATURAL (PMS #12-0703 TCX)
HANDLE	Top Panel: 1 Piece cotton twill fabric NATURAL (PMS #12-0703 TCX) Strap Handle; 12" x 2"; Center of top panel; Double layer twill cotton with 8G clear PVC inside, go through die cut holes (with heat seal seams) on top, sewn with "X" stitches under top panel, have PVC reinforcement under center of top panel. Heat seal all around reinforcement PVC.
GUSSET	Vendor determines gusset size

BEDDING PACKAGING SPECS

QUILTS, QUILT SETS, COVERLETS, COVERLET SETS, BEDSPREADS 19" x 15"

FRONT

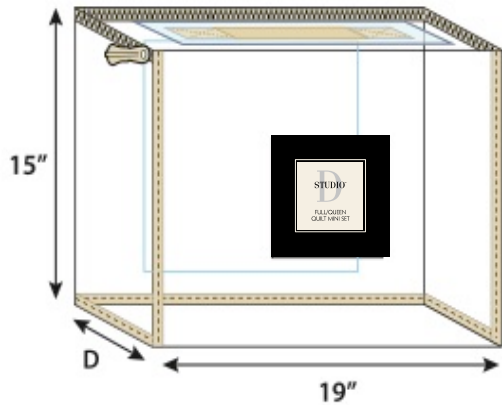

Front Pocket Size: 6.25" x 6.25"
Front Insert Size: 6" x 6"

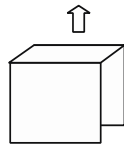

Stiffener As Needed

BACK

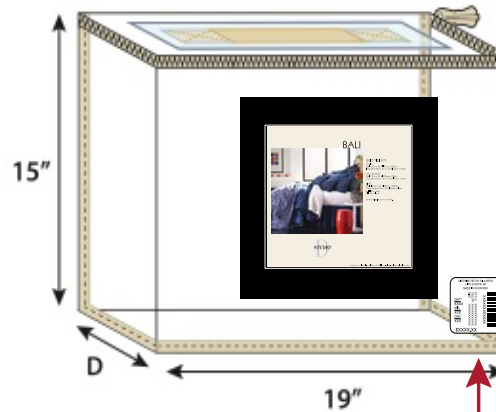

Back Pocket Size: 12.25" x 12.25"
Back Insert size: 12" x 12"

Preticket Sticker

- Lower right-hand corner on outside of vinyl bag
- Price reads horizontally

VINYL BAG AND INSERT SPECS

BAG CODE #	DL-NAT-19x15
SIZE	19" x 15" x Gusset, Thread to Thread
POCKETS	FRONT (<i>non-zipper side</i>): 6.25" x 6.25" centered
	4.375" From Bottom; 6.375" From Right Side; Center 3.2 Gauge Non-Phthalate PVC
	BACK (<i>zipper side</i>): 12.25" x 12.25" centered
	0.875" From Bottom; 3.375" From Right Side; Center 3.2 Gauge Non-Phthalate PVC
INSERT SIZES	FRONT: 6" x 6"
	BACK: 12" x 12"
BODY	All Panels: 6.0 Gauge Non-Phthalate PVC
TRIM	2 Panel Construction Trim: Cotton Twill Fabric; NATURAL (PMS #12-0703 TCX)
THREAD	On Trim: 40/2 Polyester Thread, NATURAL (PMS #12-0703 TCX)
ZIPPER	#5 Filament Zipper (PMS #12-0703 TCX) NATURAL; On top panel
SLIDER / PULL	1 Piece #5 Slider With POM Pull; NATURAL (PMS #12-0703 TCX)
HANDLE	Top Panel: 1 Piece cotton twill fabric NATURAL (PMS #12-0703 TCX) Strap Handle; 12" x 2"; Center of top panel; Double layer twill cotton with 8G clear PVC inside, go through die cut holes (with heat seal seams) on top, sewn with "X" stitches under top panel, have PVC reinforcement under center of top panel.
GUSSET	Vendor determines gusset size

BEDDING PACKAGING SPECS

DUVETS, DUVET SETS 13" x 10"

FRONT

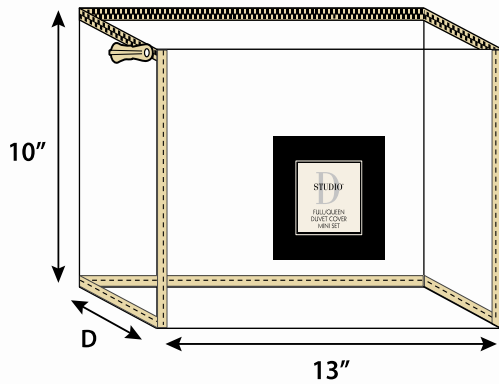

Front Pocket Size: 4.25" x 4.25"
Front Insert Size: 4" x 4"

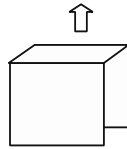

Stiffener Required

BACK

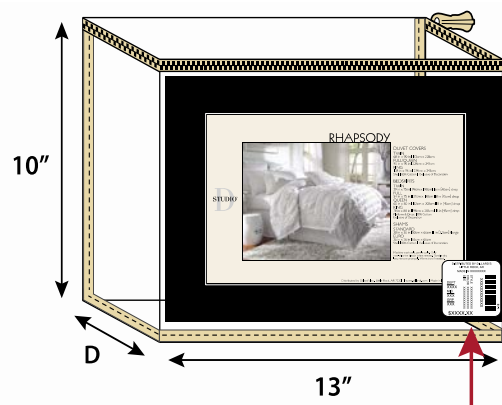

No Back Pocket
Back Insert size: 12" x 9"

Preticket Sticker

- Lower right-hand corner on outside of vinyl bag
- Price reads horizontally

VINYL BAG AND INSERT SPECS

BAG CODE #	DL-NAT-13x10
SIZE	13" x 10" x Gusset, Thread to Thread
POCKET(S)	FRONT (non-zipper side): 4.25" x 4.25" centered
	2.875" From Bottom; 4.375" From Right Side; Center 3.2 Gauge Non-Phthalate PVC
	BACK (zipper side) No Pocket
INSERT SIZES	FRONT: 4" x 4"
	BACK: 12" x 9"
BODY	All Panels: 6.0 Gauge Non-Phthalate PVC
TRIM	2 Panel Construction Trim: Cotton Twill Fabric; NATURAL (PMS #12-0703 TCX)
THREAD	On Trim: 40/2 Polyester Thread, NATURAL (PMS #12-0703 TCX)
ZIPPER	3# Filament Zipper (PMS #12-0703 TCX) NATURAL; On Top Panel
SLIDER / PULL	1 Piece #3 Slider With POM Pull; NATURAL (PMS #12-0703 TCX)
GUSSET	Vendor determines gusset size

BEDDING PACKAGING SPECS

SHAMS, BED SKIRTS, DRAPES, VALANCES 11" x 9"

FRONT

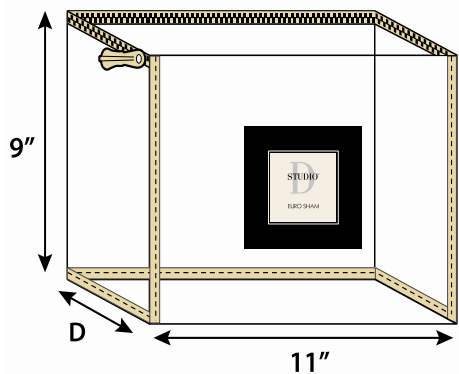

Front Pocket Size: 4.25" x 4.25"
Front Insert Size: 4" x 4"

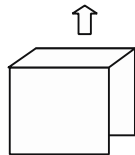

Stiffener Required

BACK

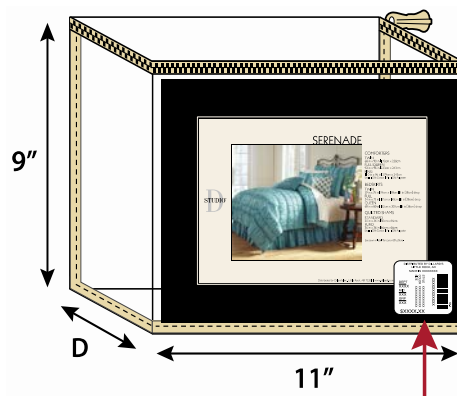

No Back Pocket
Back Insert size: 10.5" x 8"

Preticket Sticker

- Lower right-hand corner on outside of vinyl bag
- Price reads horizontally

VINYL BAG AND INSERT SPECS

BAG CODE #	DL-NAT-11x9
SIZE:	11" x 9" x Gusset, Thread to Thread
POCKET(S)	FRONT (non-zipper side): 4.25" x 4.25" centered 2.375" From Bottom; 3.375" From Right Side; Center 3.2 Gauge Non-Phthalate PVC
	BACK (zipper side) No Pocket
INSERT SIZES	FRONT: 4" x 4" BACK: 10.5" x 8"
BODY	All Panels: 6.0 Gauge Non-Phthalate PVC
TRIM	2 Panel Construction Trim: Cotton Twill Fabric; NATURAL (PMS #12-0703 TCX)
THREAD	On Trim: 40/2 Polyester Thread, NATURAL (PMS #12-0703 TCX)
ZIPPER	3# Filament Zipper (PMS #12-0703 TCX) NATURAL; On Top Panel
SLIDER / PULL	1 Piece #3 Slider With POM Pull; NATURAL (PMS #12-0703 TCX)
GUSSET	Vendor determines gusset size

BEDDING PACKAGING SPECS

Southern Living

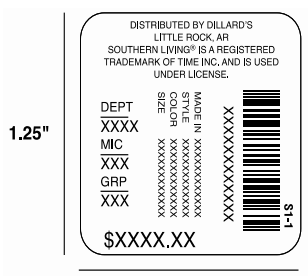
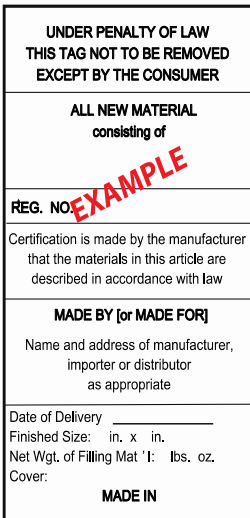

All Artwork Is For Reference Only

WOVEN LABEL SL50LW	PRE-TICKET STICKER SLSML-125P	LAW LABEL Use As Needed Added by Vendor
		

PRINTED INSERTS COLORS

Front Inserts



Colors:

	
35% PMS 468 Matte	PMS Warm Gray 8 Matte

MATTE FINISH

Back Inserts

Colors:

		
35% PMS 468 Matte	PMS Warm Gray 8 Matte	4 Color Process

MATTE FINISH



PAPER WEIGHT FOR PRINTED INSERTS

Paper weight: 18PTC1S: 280gsm

VINYL BAG: TWILL FABRIC, ZIPPER AND POM PULL COLOR

Natural; 35% PMS 468 C or PMS 12-0703 TCX

Colors:

	- or -	
35% PMS 468 C		12-0703 TCX

BEDDING PACKAGING SPECS

COMFORTERS, COMFORTER SETS 23" x 23"

FRONT

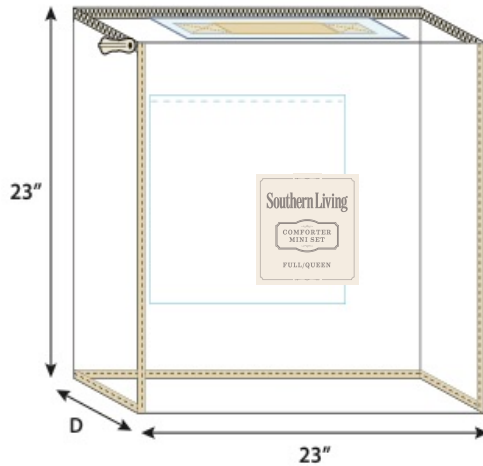

Front Pocket Size: 6.25" x 6.25"
Front Insert Size: 6" x 6"

BACK

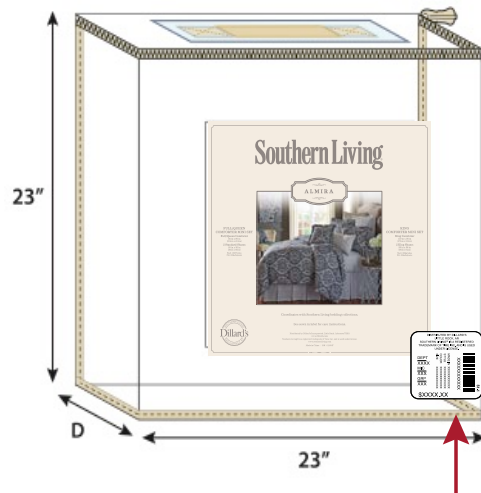

Back Pocket Size: 14.25" x 14.25"
Back Insert Size: 14" x 14"

Preticket Sticker

- Lower right-hand corner on outside of vinyl bag
- Price reads horizontally

VINYL BAG AND INSERT SPECS

BAG CODE #	DL-NAT-23x23
SIZE	23" x 23" x Gusset, Thread to Thread
POCKETS	FRONT (non-zipper side): 6.25" x 6.25" centered 8.375" From Bottom; 8.375" From Right Side; Center 3.2 Gauge Non-Phthalate PVC
	BACK (zipper side) : 14.25" x 14.25" centered 3.875" From Bottom; 4.375" From Right Side; Center 3.2 Gauge Non-Phthalate PVC
INSERT SIZES	FRONT: 6" x 6"
	BACK: 14" x 14"
BODY	All Panels: 6.0 Gauge Non-Phthalate PVC
TRIM	2 Panel Construction Trim: Cotton Twill Fabric; NATURAL (PMS #12-0703 TCX)
THREAD	On Trim: 40/2 Polyester Thread, NATURAL (PMS #12-0703 TCX)
ZIPPER	5# Filament Zipper (PMS #12-0703 TCX) NATURAL; On Top Panel
SLIDER / PULL	1 Piece #5 Slider With POM Pull; NATURAL (PMS #12-0703 TCX)
HANDLE	Top Panel: 1 Piece cotton twill fabric NATURAL (PMS #12-0703 TCX) Strap Handle; 12" x 2"; Center of top panel; Double layer twill cotton with 8G clear PVC inside, go through die cut holes (with heat seal seams) on top, sewn with "X" stitches under top panel, have PVC reinforcement under center of top panel. Heat seal all around reinforcement PVC.
GUSSET	Vendor determines gusset size

BEDDING PACKAGING SPECS

QUILTS, QUILT SETS, COVERLETS, COVERLET SETS, BEDSPREADS 19" x 15"

FRONT

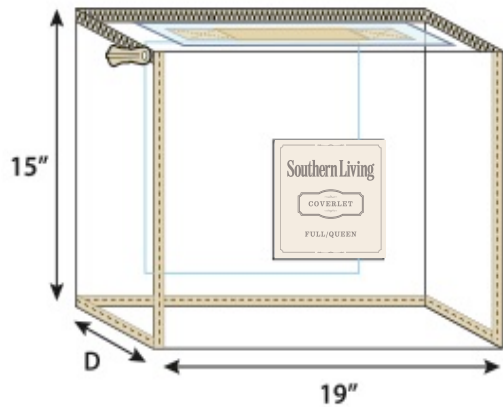

Front Pocket Size: 6.25" x 6.25"
Front Insert Size: 6" x 6"

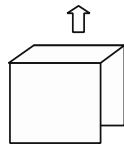

Stiffener As Needed

BACK

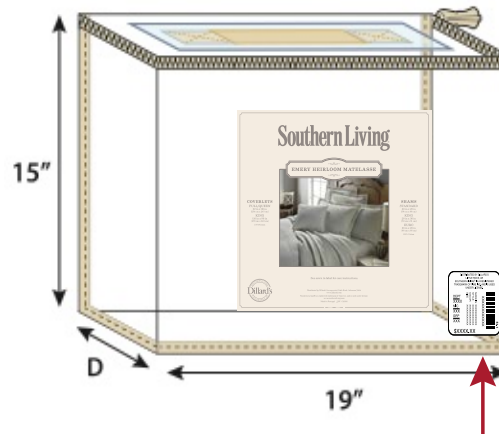

Back Pocket Size: 12.25" x 12.25"
Back Insert size: 12" x 12"

Preticket Sticker

- Lower right-hand corner on outside of vinyl bag
- Price reads horizontally

VINYL BAG AND INSERT SPECS

BAG CODE #	DL-NAT-19x15
SIZE	19" x 15" x Gusset, Thread to Thread
POCKETS	FRONT (non-zipper side): 6.25" x 6.25" centered
	4.375" From Bottom; 6.375" From Right Side; Center 3.2 Gauge Non-Phthalate PVC
	BACK (zipper side) : 12.25" x 12.25" centered
	0.875" From Bottom; 3.375" From Right Side; Center 3.2 Gauge Non-Phthalate PVC
INSERT SIZES	FRONT: 6" x 6"
	BACK: 12" x 12"
BODY	All Panels: 6.0 Gauge Non-Phthalate PVC
TRIM	2 Panel Construction Trim: Cotton Twill Fabric; NATURAL (PMS #12-0703 TCX)
THREAD	On Trim: 40/2 Polyester Thread, NATURAL (PMS #12-0703 TCX)
ZIPPER	#5 Filament Zipper (PMS #12-0703 TCX) NATURAL; On top panel
SLIDER / PULL	1 Piece #5 Slider With POM Pull; NATURAL (PMS #12-0703 TCX)
HANDLE	Top Panel: 1 Piece cotton twill fabric NATURAL (PMS #12-0703 TCX) Strap Handle; 12" x 2"; Center of top panel; Double layer twill cotton with 8G clear PVC inside, go through die cut holes (with heat seal seams) on top, sewn with "X" stitches under top panel, have PVC reinforcement under center of top panel.
GUSSET	Vendor determines gusset size

BEDDING PACKAGING SPECS

DUVETS, DUVET SETS 13" x 10"

FRONT

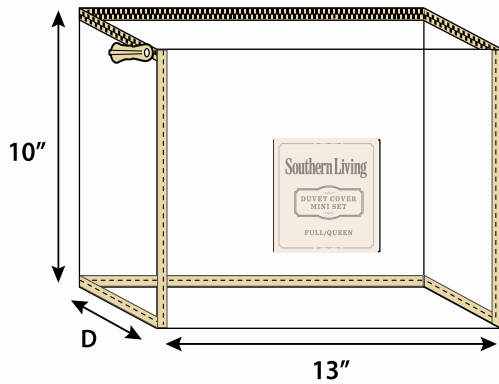

Front Pocket Size: 4.25" x 4.25"
Front Insert Size: 4" x 4"

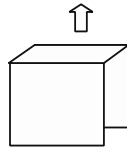

Stiffener Required

BACK

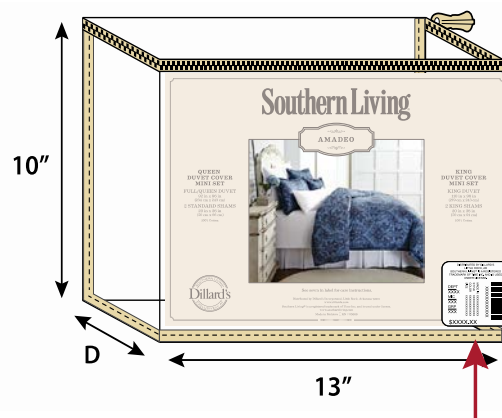

No Back Pocket
Back Insert size: 12" x 9"

Preticket Sticker

- Lower right-hand corner on outside of vinyl bag
- Price reads horizontally

VINYL BAG AND INSERT SPECS

BAG CODE #	DL-NAT-13x10
SIZE	13" x 10" x Gusset, Thread to Thread
POCKET(S)	FRONT (non-zipper side): 4.25" x 4.25" centered
	2.875" From Bottom; 4.375" From Right Side; Center 3.2 Gauge Non-Phthalate PVC
	BACK (zipper side) No Pocket
INSERT SIZES	FRONT: 4" x 4"
	BACK: 12" x 9"
BODY	All Panels: 6.0 Gauge Non-Phthalate PVC
TRIM	2 Panel Construction Trim: Cotton Twill Fabric; NATURAL (PMS #12-0703 TCX)
THREAD	On Trim: 40/2 Polyester Thread, NATURAL (PMS #12-0703 TCX)
ZIPPER	3# Filament Zipper (PMS #12-0703 TCX) NATURAL; On Top Panel
SLIDER / PULL	1 Piece #3 Slider With POM Pull; NATURAL (PMS #12-0703 TCX)
GUSSET	Vendor determines gusset size

BEDDING PACKAGING SPECS

SHAMS, BED SKIRTS, DRAPES, VALANCES 11" x 9"

FRONT

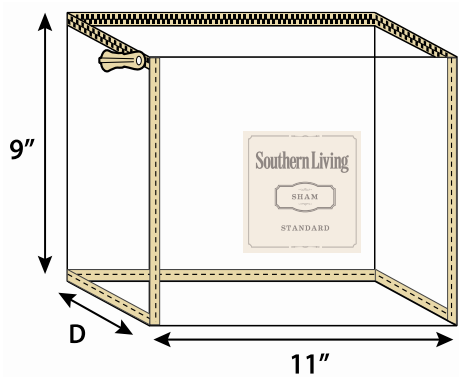

Front Pocket Size: 4.25" x 4.25"
Front Insert Size: 4" x 4"

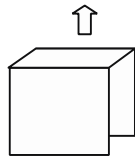

Stiffener Required

BACK

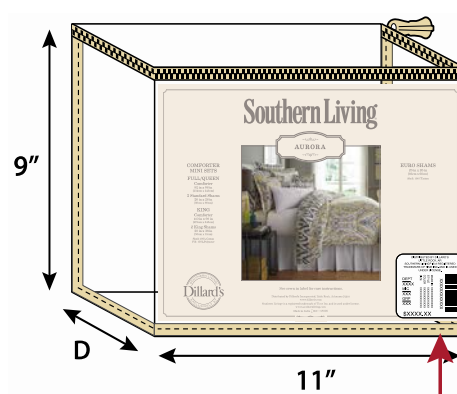

No Back Pocket
Back Insert size: 10.5" x 8"

Preticket Sticker

- Lower right-hand corner on outside of vinyl bag
- Price reads horizontally

VINYL BAG AND INSERT SPECS

BAG CODE #	DL-NAT-11x9
SIZE:	11" x 9" x Gusset, Thread to Thread
POCKET(S)	FRONT (non-zipper side): 4.25" x 4.25" centered
	2.375" From Bottom; 3.375" From Right Side; Center 3.2 Gauge Non-Phthalate PVC
	BACK (zipper side) No Pocket
INSERT SIZES	FRONT: 4" x 4"
	BACK: 10.5" x 8"
BODY	All Panels: 6.0 Gauge Non-Phthalate PVC
TRIM	2 Panel Construction Trim: Cotton Twill Fabric; NATURAL (PMS #12-0703 TCX)
THREAD	On Trim: 40/2 Polyester Thread, NATURAL (PMS #12-0703 TCX)
ZIPPER	3# Filament Zipper (PMS #12-0703 TCX) NATURAL; On Top Panel
SLIDER / PULL	1 Piece #3 Slider With POM Pull; NATURAL (PMS #12-0703 TCX)
GUSSET	Vendor determines gusset size



BEDDING PACKAGING SPECS

Cremieux

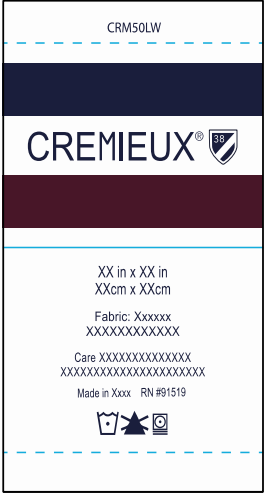
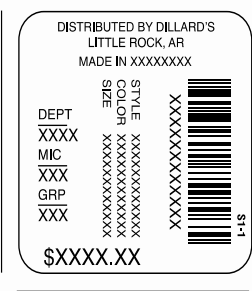
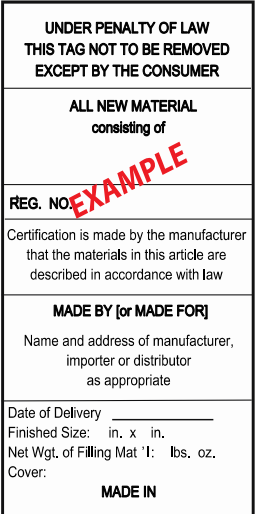
All Artwork Is For Reference Only

WOVEN LABEL	PRE-TICKET STICKER	LAW LABEL Use As Needed
<p>CRM50LW</p> 	<p>DMSML-125P</p> 	<p>Added by Vendor</p> 

PRINTED INSERTS COLORS

Front Inserts	Back Inserts
<p>Colors:</p>  <p>PASTEL PMS 9043 C PMS 533 C</p>	<p>Colors:</p>  <p>PASTEL PMS 9043 C PMS 533 C 4 Color Process</p>
MATTE FINISH	MATTE FINISH

PAPER WEIGHT FOR PRINTED INSERTS

Paper weight: 18PTC1S: 280gsm

VINYL BAG: TWILL FABRIC, ZIPPER AND POM PULL COLOR

Natural; 35% PMS 468 C or PMS 12-0703 TCX

Colors:

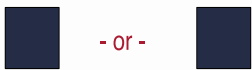

PMS 532 C - or - 19-3815 TCX

BEDDING PACKAGING SPECS

COMFORTERS, COMFORTER SETS 23" x 23"

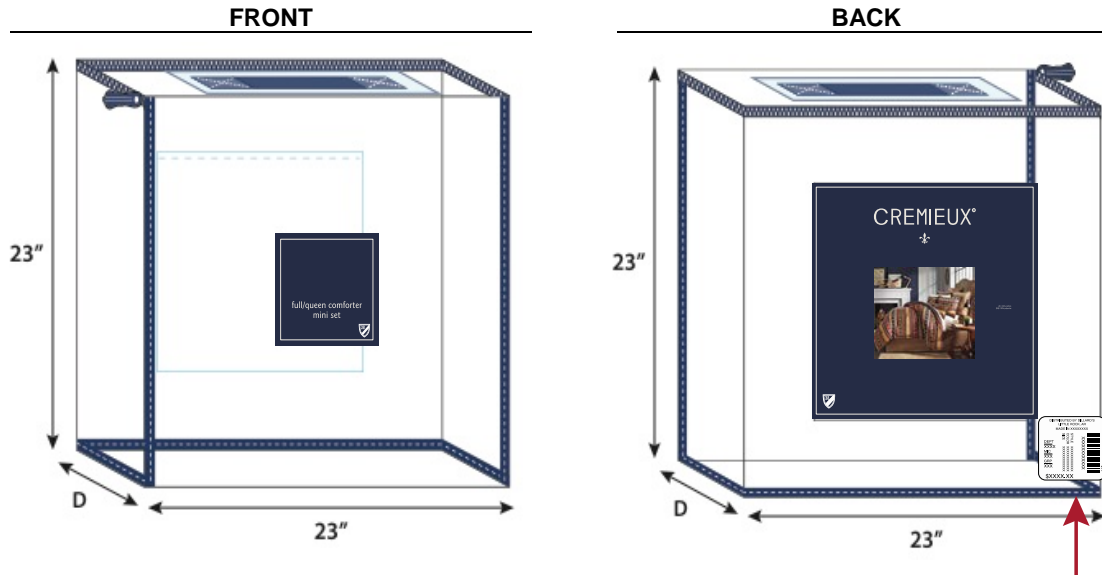

Front Pocket Size: 6.25" x 6.25"
 Front Insert Size: 6" x 6"

Back Pocket Size: 14.25" x 14.25"
 Back Insert Size: 14" x 14"

Preticket Sticker

- Lower right-hand corner on outside of vinyl bag
- Price reads horizontally

VINYL BAG AND INSERT SPECS

BAG CODE #	DL-NAV-23x23
SIZE	23" x 23" x Gusset, Thread to Thread
POCKETS	FRONT (non-zipper side): 6.25" x 6.25" centered 8.375" From Bottom; 8.375" From Right Side; Center 3.2 Gauge Non-Phthalate PVC
	BACK (zipper side) : 14.25" x 14.25" centered 3.875" From Bottom; 4.375" From Right Side; Center 3.2 Gauge Non-Phthalate PVC
INSERT SIZES	FRONT: 6" x 6"
	BACK: 14" x 14"
BODY	All Panels: 6.0 Gauge Non-Phthalate PVC
TRIM	2 Panel Construction Trim: Cotton Twill Fabric; NAVY BLUE (PMS #19-3815 TCX)
THREAD	On Trim: 40/2 Polyester Thread, NAVY BLUE (PMS #19-3815 TCX)
ZIPPER	5# Filament Zipper (PMS #19-3815 TCX) NAVY BLUE; On top panel with PVC strips added for color protection
SLIDER / PULL	1 Piece #5 Slider With POM Pull; NAVY BLUE (PMS #19-3815 TCX)
HANDLE	Top Panel: 1 Piece cotton twill fabric NAVY BLUE (PMS #19-3815 TCX) Strap Handle; 12" x 2"; Center of top panel; Double layer twill cotton with 8G clear PVC inside, go through die cut holes (with heat seal seams) on top, sewn with "X" stitches under top panel, have PVC reinforcement under center of top panel. Heat seal all around reinforcement PVC.
GUSSET	Vendor determines gusset size

BEDDING PACKAGING SPECS

QUILTS, QUILT SETS, COVERLETS, COVERLET SETS, BEDSPREADS 19" x 15"

FRONT

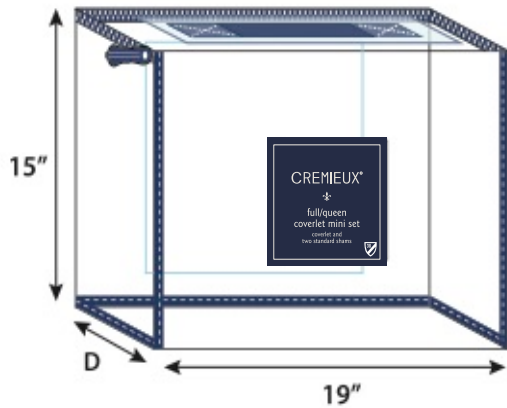

Front Pocket Size: 6.25" x 6.25"
Front Insert Size: 6" x 6"

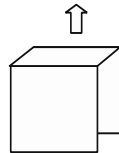

Stiffener As Needed

BACK

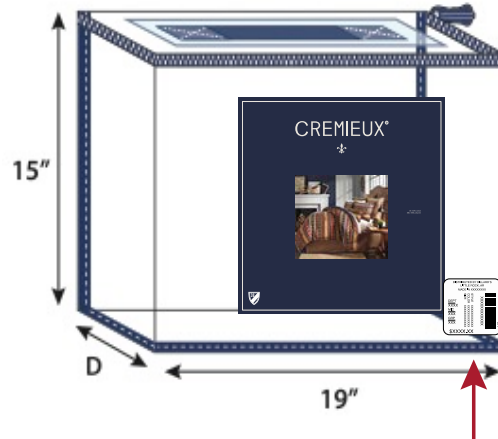

Back Pocket Size: 12.25" x 12.25"
Back Insert size: 12" x 12"

Preticket Sticker

- Lower right-hand corner on outside of vinyl bag
- Price reads horizontally

VINYL BAG AND INSERT SPECS

BAG CODE #	DL-NAV-19x15
SIZE	19" x 15" x Gusset, Thread to Thread
POCKETS	FRONT (non-zipper side): 6.25" x 6.25" centered
	4.375" From Bottom; 6.375" From Right Side; Center 3.2 Gauge Non-Phthalate PVC
	BACK (zipper side) : 12.25" x 12.25" centered
	0.875" From Bottom; 3.375" From Right Side; Center 3.2 Gauge Non-Phthalate PVC
INSERT SIZES	FRONT: 6" x 6"
	BACK: 12" x 12"
BODY	All Panels: 6.0 Gauge Non-Phthalate PVC
TRIM	2 Panel Construction Trim: Cotton Twill Fabric; NAVY BLUE (PMS #19-3815 TCX)
THREAD	On Trim: 40/2 Polyester Thread, NAVY BLUE (PMS #19-3815 TCX)
ZIPPER	#5 Filament Zipper (PMS #19-3815 TCX) NAVY BLUE; On top panel with PVC strips added for color protection.
SLIDER / PULL	1 Piece #5 Slider With POM Pull; NAVY BLUE (PMS #19-3815 TCX)
HANDLE	Top Panel: 1 Piece cotton twill fabric NAVY BLUE (PMS #19-3815 TCX) Strap Handle; 12" x 2"; Center of top panel; Double layer twill cotton with 8G clear PVC inside, go through die cut holes (with heat seal seams) on top, sewn with "X" stitches under top panel, have PVC reinforcement under center of top panel.
GUSSET	Vendor determines gusset size

BEDDING PACKAGING SPECS

DUVETS, DUVET SETS 13" x 10"

FRONT

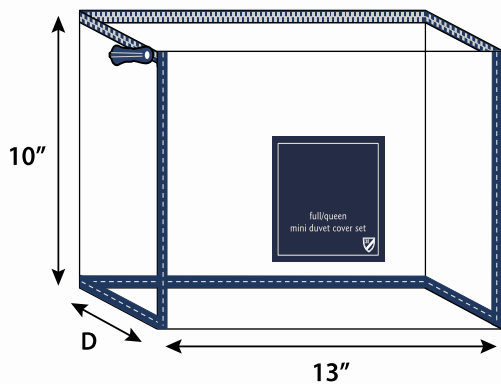

Front Pocket Size: 4.25" x 4.25"
Front Insert Size: 4" x 4"

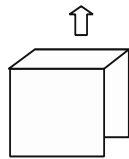

Stiffener Required

BACK

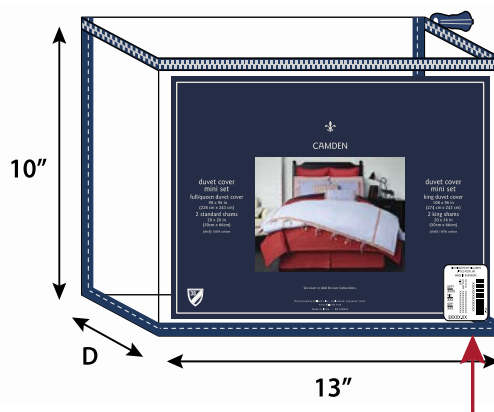

No Back Pocket
Back Insert size: 12" x 9"

Preticket Sticker

- Lower right-hand corner on outside of vinyl bag
- Price reads horizontally

VINYL BAG AND INSERT SPECS

BAG CODE #	DL-NAV-13x10
SIZE	13" x 10" x Gusset, Thread to Thread
POCKET(S)	FRONT (non-zipper side): 4.25" x 4.25" centered
	2.875" From Bottom; 4.375" From Right Side; Center 3.2 Gauge Non-Phthalate PVC
	BACK (zipper side) No Pocket
INSERT SIZES	FRONT: 4" x 4"
	BACK: 12" x 9"
BODY	All Panels: 6.0 Gauge Non-Phthalate PVC
TRIM	2 Panel Construction Trim: Cotton Twill Fabric; NAVY BLUE (PMS #19-3815 TCX)
THREAD	On Trim: 40/2 Polyester Thread, NAVY BLUE (PMS #19-3815 TCX)
ZIPPER	3# Filament Zipper (PMS #19-3815 TCX) NAVY BLUE; On top panel with PVC strips added for color protection
SLIDER / PULL	1 Piece #3 Slider With POM Pull; NAVY BLUE (PMS #19-3815 TCX)
GUSSET	Vendor determines gusset size

BEDDING PACKAGING SPECS

SHAMS, BED SKIRTS, DRAPES, VALANCES 11" x 9"

FRONT

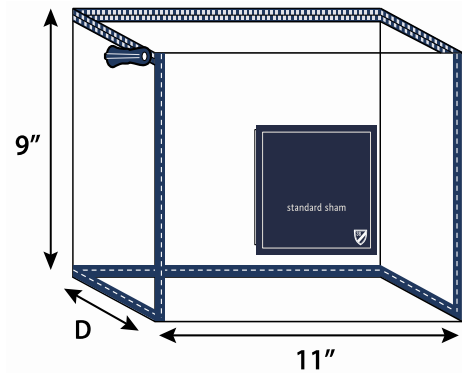

Front Pocket Size: 4.25" x 4.25"
Front Insert Size: 4" x 4"

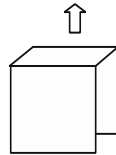

Stiffener Required

BACK

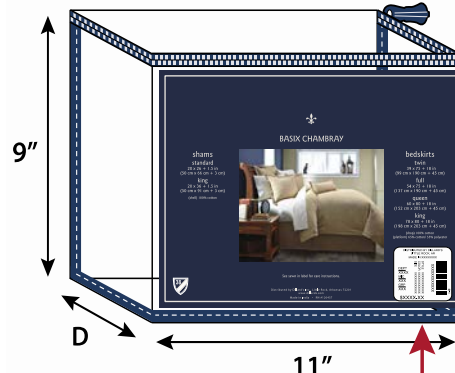

No Back Pocket
Back Insert size: 10.5" x 8"

Preticket Sticker

- Lower right-hand corner on outside of vinyl bag
- Price reads horizontally

VINYL BAG AND INSERT SPECS

BAG CODE #	DL-NAV-11x9
SIZE:	11" x 9" x Gusset, Thread to Thread
POCKET(S)	FRONT (non-zipper side): 4.25" x 4.25" centered 2.375" From Bottom; 3.375" From Right Side; Center 3.2 Gauge Non-Phthalate PVC
	BACK (zipper side) No Pocket
INSERT SIZES	FRONT: 4" x 4" BACK: 10.5" x 8"
BODY	All Panels: 6.0 Gauge Non-Phthalate PVC
TRIM	2 Panel Construction Trim: Cotton Twill Fabric; NAVY BLUE (PMS #19-3815 TCX)
THREAD	On Trim: 40/2 Polyester Thread, NAVY BLUE (PMS #19-3815 TCX)
ZIPPER	3# Filament Zipper (PMS #19-3815 TCX) NAVY BLUE; On top panel with PVC strips added for color protection
SLIDER / PULL	1 Piece #3 Slider With POM Pull; NAVY BLUE (PMS #19-3815 TCX)
GUSSET	Vendor determines gusset size

SHEET PACKAGING SPECS

Noble Excellence

All Artwork Is For Reference Only

WOVEN LABEL

NE50LW

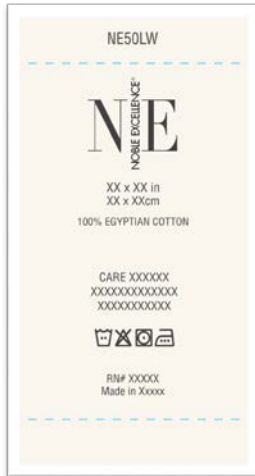

PRE-TICKET STICKER

DMSML-125P

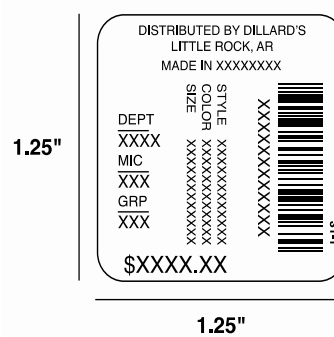

PRINTED INSERT COLORS

Front Inserts

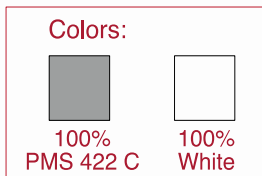

MATTE FINISH

Back Inserts

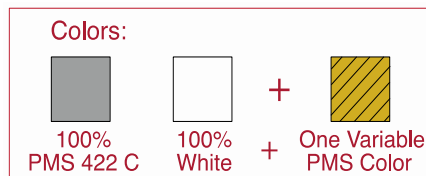

MATTE FINISH

PAPER WEIGHT FOR PRINTED INSERTS

Paper weight: 18PTC1S: 280gsm

VINYL BAG: TWILL FABRIC, ZIPPER AND POM PULL COLOR

Natural; 35% PMS 468 C or PMS 12-0703 TCX

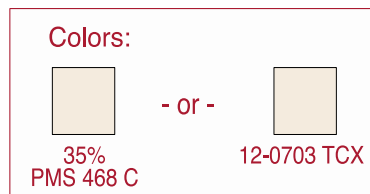

SHEET PACKAGING SPECS

SHEET SETS 11" x 9"

FRONT

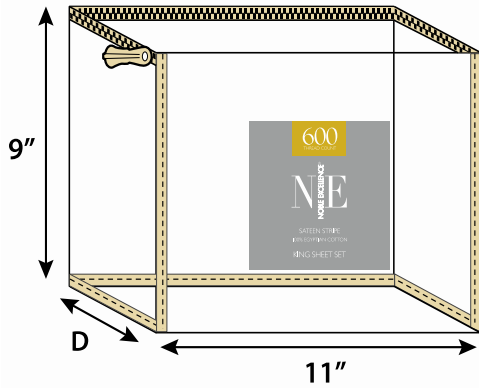

Front Pocket Size: 4.25" x 4.25"
Front Insert Size: 4" x 4"

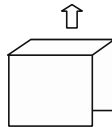

Stiffener Required

BACK

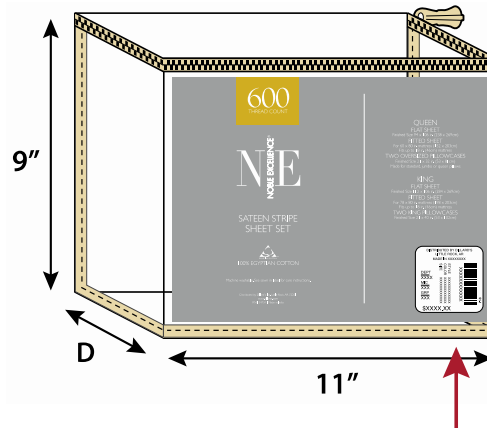

No Back Pocket
Back Insert Size: 10.5" x 8"

Preticket Sticker
Lower right-hand corner
on outside of vinyl bag
Price reads horizontally

VINYL BAG AND INSERT SPECS

BAG CODE #	DL-NAT-11x9
SIZE	11" x 9" x Gusset, Thread to Thread
POCKET(S)	FRONT (non-zipper side): 4.25" x 4.25" centered 2.375" From Bottom; 3.375" From Right Side; Center 3.2 Gauge Non-Phthalate PVC
	BACK (zipper side) No Pocket
INSERT SIZES	FRONT: 4" x 4" BACK: 10.5" x 8"
BODY	All Panels: 6.0 Gauge Non-Phthalate PVC
TRIM	2 Panel Construction Trim: Cotton Twill Fabric; NATURAL (PMS #12-0703 TCX)
THREAD	On Trim: 40/2 Polyester Thread, NATURAL (PMS #12-0703 TCX)
ZIPPER	3# Filament Zipper (PMS #12-0703 TCX) NATURAL; On Top Panel
SLIDER / PULL	1 Piece #3 Slider With POM Pull; NATURAL (PMS #12-0703 TCX)
GUSSET	Vendor determines gusset size

SHEET PACKAGING SPECS

PILLOWCASES 5.5" x 9"

FRONT

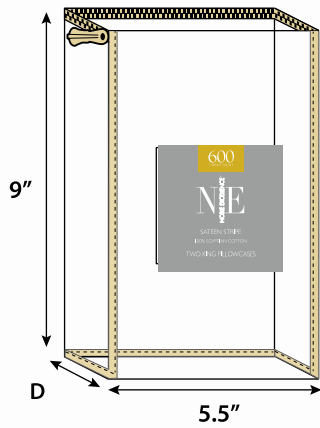

Front Pocket Size: 3.25" x 3.25"
 Front Insert Size: 3" x 3"

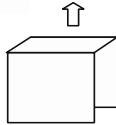

Stiffener Required

BACK

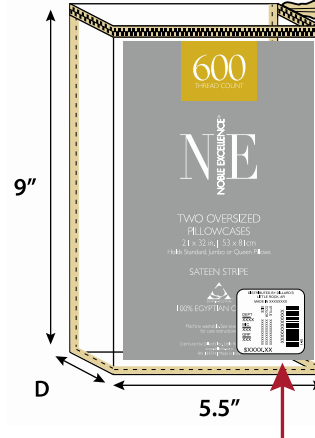

No Back Pocket
 Back Insert Size: 5.25" x 8.25"

Preticket Sticker

- Lower right-hand corner on outside of vinyl bag
- Price reads horizontally

BAG AND INSERT SPECS

BAG CODE #	DL-NAT-5.5x9
SIZE	5.5" x 9" x Gusset, Thread to Thread
POCKET(S)	FRONT (non-zipper side): 3.25" x 3.25" centered 2.875" From Bottom; 1.125" From Right Side; Center 3.2 Gauge Non-Phthalate PVC
	BACK (zipper side) No Pocket
INSERT SIZES	FRONT: 3" x 3" BACK: 5.25" x 8.25"
BODY	All Panels: 6.0 Gauge Non-Phthalate PVC
TRIM	2 Panel Construction Trim: Cotton Twill Fabric; NATURAL (PMS #12-0703 TCX)
THREAD	On Trim: 40/2 Polyester Thread, NATURAL (PMS #12-0703 TCX)
ZIPPER	3# Filament Zipper (PMS #12-0703 TCX) NATURAL; On Top Panel
SLIDER / PULL	1 Piece #3 Slider With POM Pull; NATURAL (PMS #12-0703 TCX)
GUSSET	Vendor determines gusset size

SHEET PACKAGING SPECS

Southern Living

All Artwork Is For Reference Only

WOVEN LABEL

SL50LW



PRE-TICKET STICKER

SLSML-125P

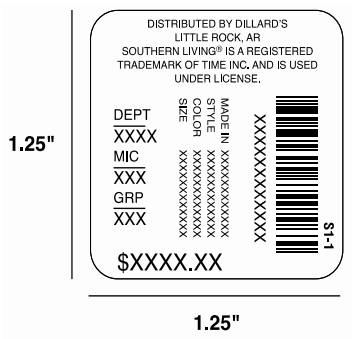

PRINTED INSERT COLORS

Front Inserts

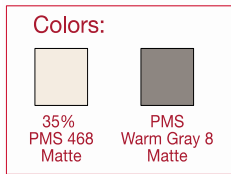

Back Inserts

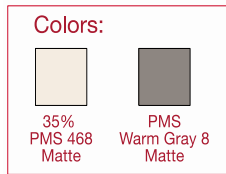

MATTE FINISH

MATTE FINISH

PAPER WEIGHT FOR PRINTED INSERTS

Paper weight: 18PTC1S: 280gsm

VINYL BAG: TWILL FABRIC, ZIPPER AND POM PULL COLOR

Natural; 35% PMS 468 C or PMS 12-0703 TCX

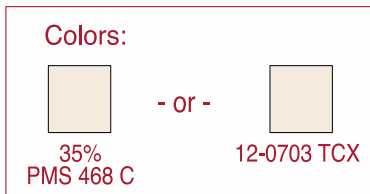

SHEET PACKAGING SPECS

SHEET SETS 11" x 9"

FRONT

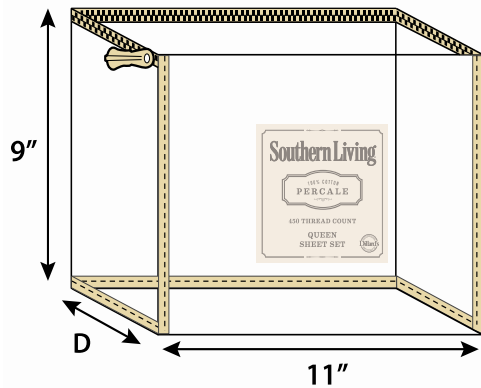

Front Pocket Size: 4.25" x 4.25"
Front Insert Size: 4" x 4"

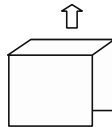

Stiffener Required

BACK

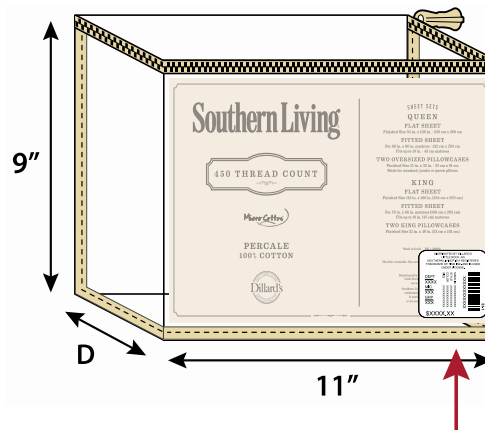

No Back Pocket
Back Insert Size: 10.5" x 8"

Preticket Sticker
Lower right-hand corner
on outside of vinyl bag
Price reads horizontally

VINYL BAG AND INSERT SPECS

BAG CODE #	DL-NAT-11x9
SIZE	11" x 9" x Gusset, Thread to Thread
POCKET(S)	FRONT (non-zipper side): 4.25" x 4.25" centered 2.375" From Bottom; 3.375" From Right Side; Center 3.2 Gauge Non-Phthalate PVC
	BACK (zipper side) No Pocket
INSERT SIZES	FRONT: 4" x 4" BACK: 10.5" x 8"
BODY	All Panels: 6.0 Gauge Non-Phthalate PVC
TRIM	2 Panel Construction Trim: Cotton Twill Fabric; NATURAL (PMS #12-0703 TCX)
THREAD	On Trim: 40/2 Polyester Thread, NATURAL (PMS #12-0703 TCX)
ZIPPER	3# Filament Zipper (PMS #12-0703 TCX) NATURAL; On Top Panel
SLIDER / PULL	1 Piece #3 Slider With POM Pull; NATURAL (PMS #12-0703 TCX)
GUSSET	Vendor determines gusset size

SHEET PACKAGING SPECS

PILLOWCASES 5.5" x 9"

FRONT

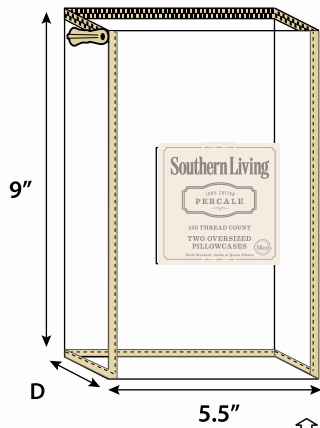

Front Pocket Size: 3.25" x 3.25"
 Front Insert Size: 3" x 3"

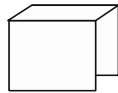

Stiffener Required

BACK



No Back Pocket
 Back Insert Size: 5.25" x 8.25"

Preticket Sticker

- Lower right-hand corner on outside of vinyl bag
- Price reads horizontally

BAG AND INSERT SPECS

BAG CODE #	DL-NAT-5.5x9
SIZE	5.5" x 9" x Gusset, Thread to Thread
POCKET(S)	FRONT (non-zipper side): 3.25" x 3.25" centered
	2.875" From Bottom; 1.125" From Right Side; Center 3.2 Gauge Non-Phthalate PVC
	BACK (zipper side) No Pocket
INSERT SIZES	FRONT: 3" x 3"
	BACK: 5.25" x 8.25"
BODY	All Panels: 6.0 Gauge Non-Phthalate PVC
TRIM	2 Panel Construction Trim: Cotton Twill Fabric; NATURAL (PMS #12-0703 TCX)
THREAD	On Trim: 40/2 Polyester Thread, NATURAL (PMS #12-0703 TCX)
ZIPPER	3# Filament Zipper (PMS #12-0703 TCX) NATURAL; On Top Panel
SLIDER / PULL	1 Piece #3 Slider With POM Pull; NATURAL (PMS #12-0703 TCX)
GUSSET	Vendor determines gusset size

SHOWER CURTAIN PACKAGING SPECS

Noble Excellence All Artwork Is For Reference Only

WOVEN LABEL

NE50LW

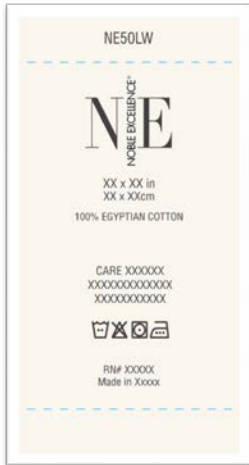

PRE-TICKET STICKER

DMSML-125P

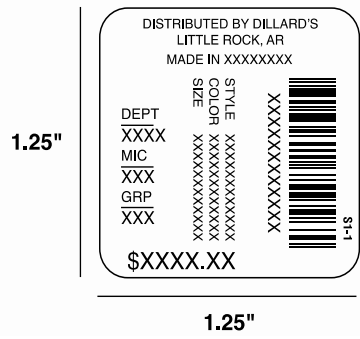

PRINTED INSERT COLORS

Front Inserts

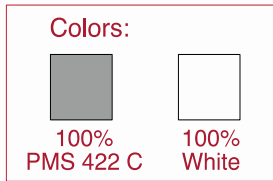

Back Inserts

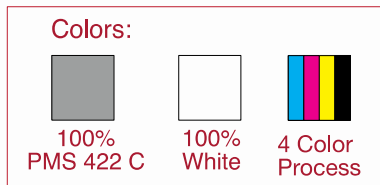

MATTE FINISH

MATTE FINISH

PAPER WEIGHT FOR PRINTED INSERTS

Paper weight: 18PTC1S: 280gsm

VINYL BAG: TWILL FABRIC, ZIPPER AND POM PULL COLOR

Natural; 35% PMS 468 C or PMS 12-0703 TCX

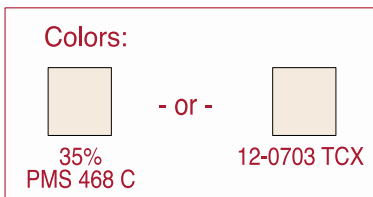

SHOWER CURTAIN PACKAGING SPECS

SHOWER CURTAINS 9" x 11"

FRONT

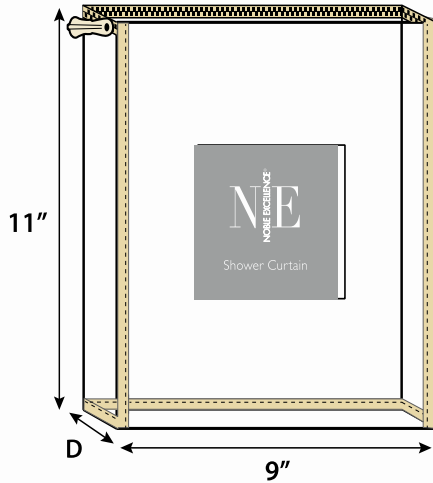

Front Pocket Size: 4.25" x 4.25"
Front Insert Size: 4" x 4"

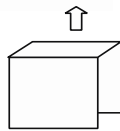

Stiffener Required

BACK



No Back Pocket
Back Insert Size: 8.5" x 10"

Preticket Sticker

- Lower right-hand corner on outside of vinyl bag
- Price reads horizontally

VINYL BAG AND INSERT SPECS

BAG CODE #	DL-NAT-9x11
SIZE	9" x 11" x Gusset, Thread to Thread
POCKET(S)	FRONT (non-zipper side): 4.25" x 4.25" centered 3.375" From Bottom; 2.375" From Right Side; Center 3.2 Gauge Non-Phthalate PVC
	BACK (zipper side) No Pocket
INSERT SIZES	FRONT: 4" x 4" BACK: 8.5" X 10"
BODY	All Panels: 6.0 Gauge Non-Phthalate PVC
TRIM	2 Panel Construction Trim: Cotton Twill Fabric; NATURAL (PMS #12-0703 TCX)
THREAD	On Trim: 40/2 Polyester Thread, NATURAL (PMS #12-0703 TCX)
ZIPPER	3# Filament Zipper (PMS #12-0703 TCX) NATURAL; On Top Panel
SLIDER / PULL	1 Piece #3 Slider With POM Pull; NATURAL (PMS #12-0703 TCX)
GUSSET	Vendor determines gusset size

SHOWER CURTAIN PACKAGING SPECS

Studio D

All Artwork Is For Reference Only

WOVEN LABEL

SD50LW



PRE-TICKET STICKER

DMSML-125P

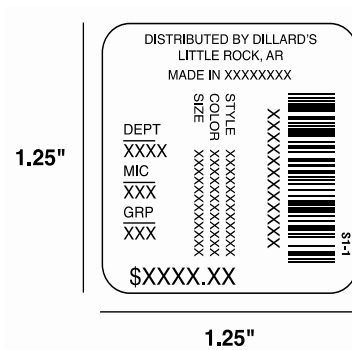

PRINTED INSERT COLORS

Front Inserts

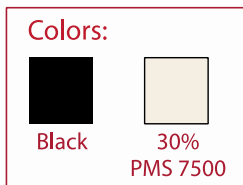

Back Inserts

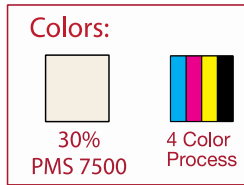

MATTE FINISH

MATTE FINISH

PAPER WEIGHT FOR PRINTED INSERTS

Paper weight: 18PTC1S: 280gsm

VINYL BAG: TWILL FABRIC, ZIPPER AND POM PULL COLOR

Natural; 35% PMS 468 C or PMS 12-0703 TCX

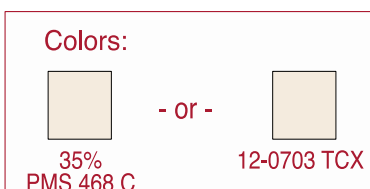

SHOWER CURTAIN PACKAGING SPECS

SHOWER CURTAINS 9" x 11"

FRONT

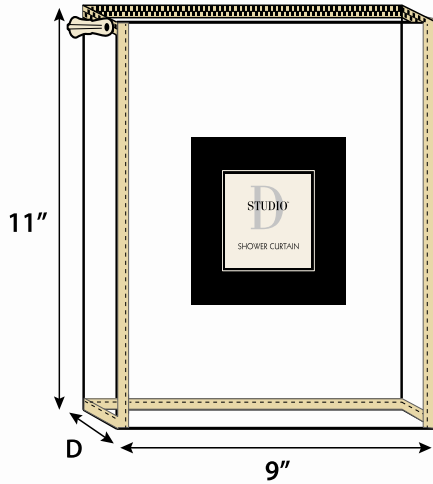

Front Pocket Size: 4.25" x 4.25"
 Front Insert Size: 4" x 4"

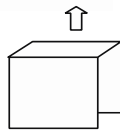

Stiffener Required

BACK

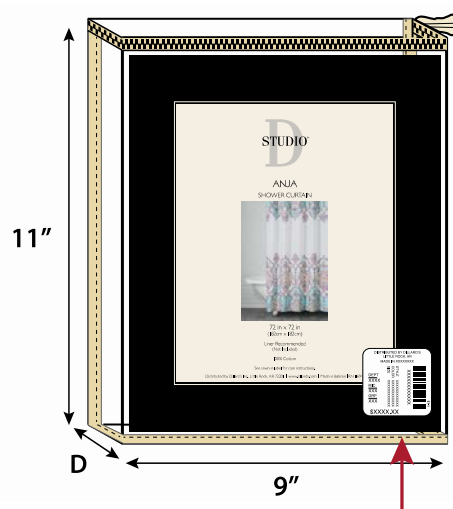

No Back Pocket
 Back Insert Size: 8.5" x 10"

Preticket Sticker

- Lower right-hand corner on outside of vinyl bag
- Price reads horizontally

VINYL BAG AND INSERT SPECS

BAG CODE #	DL-NAT-9x11
SIZE	9" x 11" x Gusset, Thread to Thread
POCKET(S)	FRONT (non-zipper side): 4.25" x 4.25" centered 3.375" From Bottom; 2.375" From Right Side; Center 3.2 Gauge Non-Phthalate PVC
	BACK (zipper side) No Pocket
INSERT SIZES	FRONT: 4" x 4"
	BACK: 8.5" X 10"
BODY	All Panels: 6.0 Gauge Non-Phthalate PVC
TRIM	2 Panel Construction Trim: Cotton Twill Fabric; NATURAL (PMS #12-0703 TCX)
THREAD	On Trim: 40/2 Polyester Thread, NATURAL (PMS #12-0703 TCX)
ZIPPER	3# Filament Zipper (PMS #12-0703 TCX) NATURAL; On Top Panel
SLIDER / PULL	1 Piece #3 Slider With POM Pull; NATURAL (PMS #12-0703 TCX)
GUSSET	Vendor determines gusset size

SHOWER CURTAIN PACKAGING SPECS

Southern Living All Artwork Is For Reference Only

WOVEN LABEL

SL50LW



PRE-TICKET STICKER

SLSML-125P

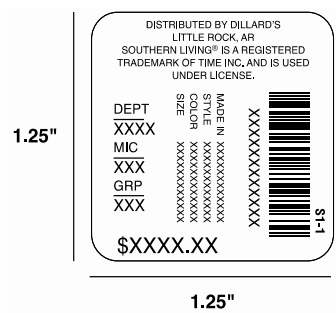

PRINTED INSERT COLORS

Front Inserts

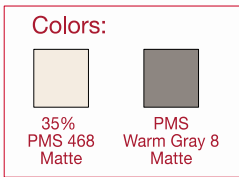

Back Inserts

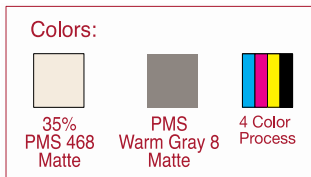

MATTE FINISH

MATTE FINISH

PAPER WEIGHT FOR PRINTED INSERTS

Paper weight: 18PTC1S: 280gsm

VINYL BAG: TWILL FABRIC, ZIPPER AND POM PULL COLOR

Natural; 35% PMS 468 C or PMS 12-0703 TCX

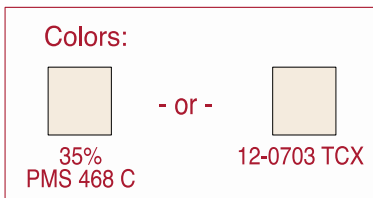

SHOWER CURTAIN PACKAGING SPECS

SHOWER CURTAINS 9" x 11"

FRONT

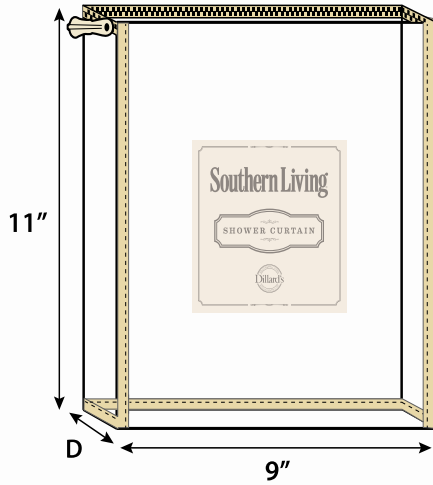

Front Pocket Size: 4.25" x 4.25"
 Front Insert Size: 4" x 4"

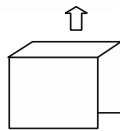

Stiffener Required

BACK



No Back Pocket
 Back Insert Size: 8.5" x 10"

Preticket Sticker

- Lower right-hand corner on outside of vinyl bag
- Price reads horizontally

VINYL BAG AND INSERT SPECS

BAG CODE #	DL-NAT-9x11
SIZE	9" x 11" x Gusset, Thread to Thread
POCKET(S)	FRONT (non-zipper side): 4.25" x 4.25" centered 3.375" From Bottom; 2.375" From Right Side; Center 3.2 Gauge Non-Phthalate PVC
	BACK (zipper side) No Pocket
INSERT SIZES	FRONT: 4" x 4" BACK: 8.5" X 10"
BODY	All Panels: 6.0 Gauge Non-Phthalate PVC
TRIM	2 Panel Construction Trim: Cotton Twill Fabric; NATURAL (PMS #12-0703 TCX)
THREAD	On Trim: 40/2 Polyester Thread, NATURAL (PMS #12-0703 TCX)
ZIPPER	3# Filament Zipper (PMS #12-0703 TCX) NATURAL; On Top Panel
SLIDER / PULL	1 Piece #3 Slider With POM Pull; NATURAL (PMS #12-0703 TCX)
GUSSET	Vendor determines gusset size

BLANKET PACKAGING SPECS

Southern Living

All Artwork Is For Reference Only

WOVEN LABEL

SL50LW



PRE-TICKET STICKER

SLSML-125P

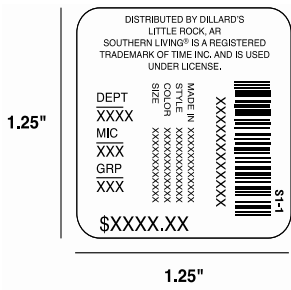

PRINTED INSERT COLORS

Front Inserts

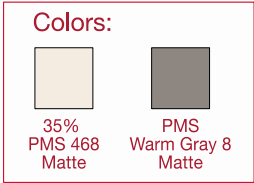

MATTE FINISH

PAPER WEIGHT FOR PRINTED INSERTS

Paper weight: 18PTC1S: 280gsm

VINYL BAG: TWILL FABRIC, ZIPPER AND POM PULL COLOR

Natural; 35% PMS 468 C or PMS 12-0703 TCX

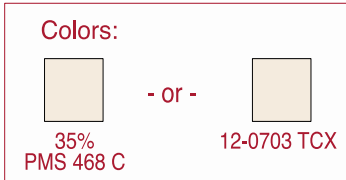

BLANKET PACKAGING SPECS

BLANKETS 13.5" x 15"

FRONT

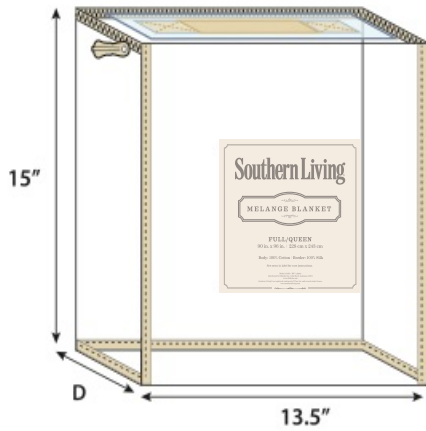

Front Pocket Size: 6.25" x 6.25"
Front Insert Size: 6" x 6"

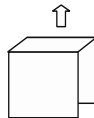

Stiffener Required

BACK

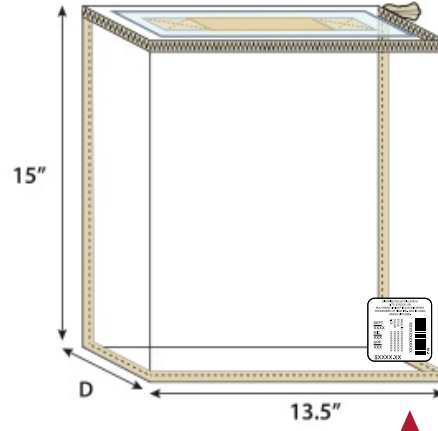

No Back Pocket
No Insert

Preticket Sticker

Lower right-hand corner
on outside of vinyl bag
Price reads horizontally

VINYL BAG AND INSERT SPECS

BAG CODE #	DL-NAT-13.5x15
SIZE	13.5" x 15" x Gusset, Thread to Thread
POCKET	FRONT (non-zipper side): 6.25" x 6.25" centered
	4.375" From Bottom; 3.625" From Right Side; Center 3.2 Gauge Non-Phthalate PVC
INSERT SIZES	FRONT: 6" x 6"
BODY	All Panels: 6.0 Gauge Non-Phthalate PVC
TRIM	2 Panel Construction Trim: Cotton Twill Fabric; NATURAL (PMS #12-0703 TCX)
THREAD	On Trim: 40/2 Polyester Thread, NATURAL (PMS #12-0703 TCX)
ZIPPER	4# Filament Zipper (PMS #12-0703 TCX) NATURAL; On Top Panel
SLIDER / PULL	1 Piece #4 Slider With POM Pull; NATURAL (PMS #12-0703 TCX)
HANDLE	Top Panel: 1 Piece cotton twill fabric NATURAL (PMS #12-0703 TCX) Strap Handle; 12" x 2"; Center of top panel; Double layer twill cotton with 8G clear PVC inside, go through die cut holes (with heat seal seams) on top, sewn with "X" stitches under top panel, have PVC reinforcement under center of top panel.
GUSSET	Vendor determines gusset size

BLANKET PACKAGING SPECS

Noble Excellence

All Artwork Is For Reference Only

WOVEN LABEL

NE50LW

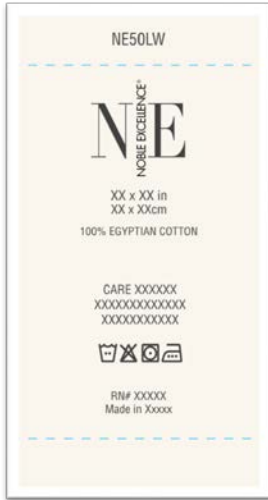

PRE-TICKET STICKER

DMSML-125P

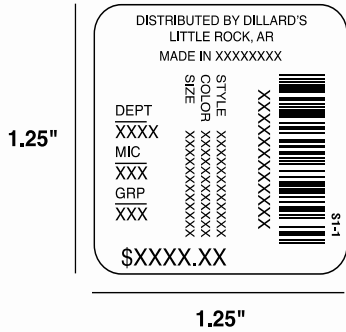

PRINTED INSERT COLORS

Front Insert

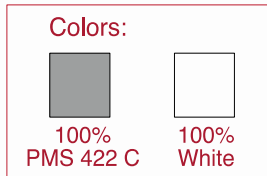

MATTE FINISH

PAPER WEIGHT FOR PRINTED INSERT

Paper weight: 18PTC1S: 280gsm

VINYL BAG: TWILL FABRIC, ZIPPER AND POM PULL COLOR

Natural; 35% PMS 468 C or PMS 12-0703 TCX

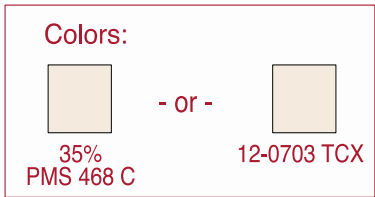

BLANKET PACKAGING SPECS

BLANKETS 13.5" x 15"

FRONT

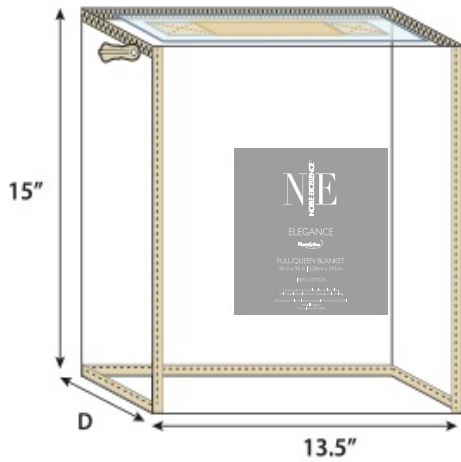

Front Pocket Size: 6.25" x 6.25"
Front Insert Size: 6" x 6"

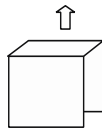

Stiffener Required

BACK

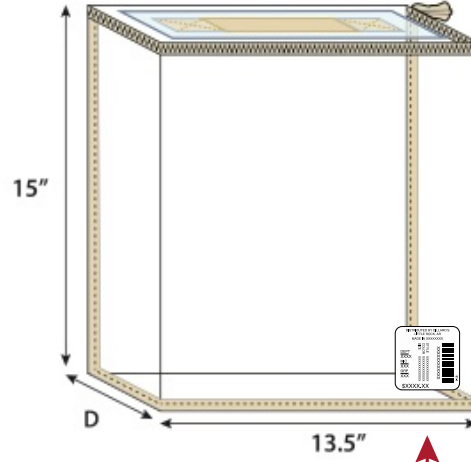

No Back Pocket
No Insert

Preticket Sticker

Lower right-hand corner
on outside of vinyl bag
Price reads horizontally

VINYL BAG AND INSERT SPECS

BAG CODE #	DL-NAT-13.5x15
SIZE	13.5" x 15" x Gusset, Thread to Thread
POCKET	FRONT (non-zipper side): 6.25" x 6.25" centered
	4.375" From Bottom; 3.625" From Right Side; Center 3.2 Gauge Non-Phthalate PVC
INSERT SIZES	FRONT: 6" x 6"
BODY	All Panels: 6.0 Gauge Non-Phthalate PVC
TRIM	2 Panel Construction Trim: Cotton Twill Fabric; NATURAL (PMS #12-0703 TCX)
THREAD	On Trim: 40/2 Polyester Thread, NATURAL (PMS #12-0703 TCX)
ZIPPER	4# Filament Zipper (PMS #12-0703 TCX) NATURAL; On Top Panel
SLIDER / PULL	1 Piece #4 Slider With POM Pull; NATURAL (PMS #12-0703 TCX)
HANDLE	Top Panel: 1 Piece cotton twill fabric NATURAL (PMS #12-0703 TCX) Strap Handle; 12" x 2"; Center of top panel; Double layer twill cotton with 8G clear PVC inside, go through die cut holes (with heat seal seams) on top, sewn with "X" stitches under top panel, have PVC reinforcement under center of top panel.
GUSSET	Vendor determines gusset size